

Data Sheet



Article number: 2310421537

Description: E+G Latch w/recessed key
CQT/T-FM-35-22-AE-VO

Measures

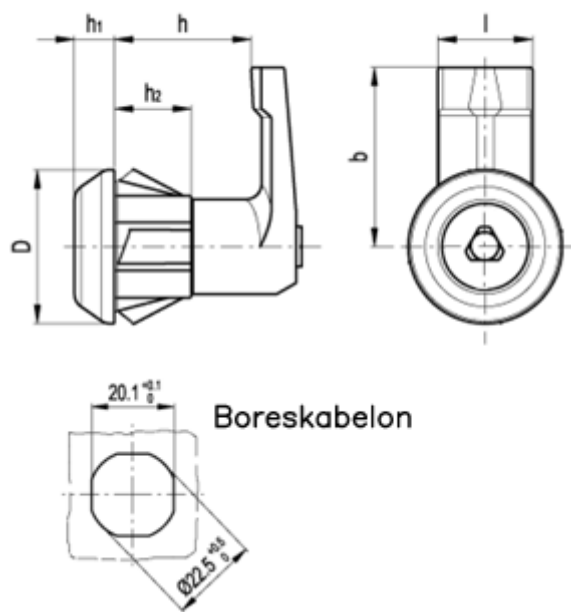

b	= 35
D	= 30
h	= 22
h1	= 8
h2	= 15
l	= 18.5
Weight	= 21